

# D-22C

## DIGITAL TRANSMITTER

### Code Setting Instructions

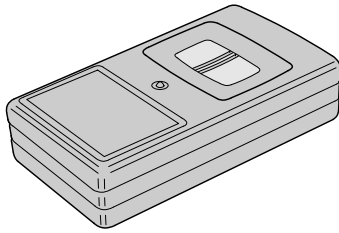

# Linear

(760) 438-7000 • FAX (760) 438-7043  
USA & Canada (800) 421-1587 & (800) 392-0123  
Toll Free FAX (800) 468-1340

### TRANSMITTER DESCRIPTION

The D-22C is a two-button, two-channel hand-held digital radio transmitter with independent button coding. The transmitter can perform a variety of remote switching tasks when used with any of Linear's Standard Digital "D" Series Receivers. Typically the D-22C is used in wireless or hybrid wireless/hardwire security systems.

The transmitter is powered by a 9-volt battery. Pressing either button will send that button's unique code. **Press either button for at least 2 seconds to activate the transmitter.** The red LED on the face of the transmitter will glow as the unit transmits and the receiver with the matching digital code will activate.

A snap-on plastic transmitter clip with a screw and double-stick tape for mounting the transmitter are provided with the unit.

The Standard Digital radio format provides up to 256 different digital codes. The code is set using the 8-position coding switches in the transmitter and receiver(s).

The D-22C transmitter contains two 8-position dipswitches, one for each pushbutton. The transmitter can be used with two single-channel receivers or one multi-channel receiver.

\* **CAUTION: All Standard Digital transmitters and receivers should be recoded prior to installation and operation.**

In order to avoid the possibility of duplicating codes in adjacent systems, factory set codes should not be used. In addition, among the valid codes available, four others should not be used. These include: all switches set ON or OFF and switches set in an alternating ON/OFF or OFF/ON pattern.

The D-22C will transmit as long as a pushbutton is pressed. Depending on conditions (interference, obstacles and distance to the receiver) the receiver output may or may not stay activated for as long as the transmitter is sending a signal.

\* **CAUTION: If using two receivers, be sure they are located at least 10 feet apart.**

**STEP 1 Locate coding switches.** The code switch for the left button can be accessed by removing the battery access door located on the back of the transmitter case. To access the code switch for the right button, the unit's rear cover must be removed. Identify the coding switches and note that they have eight positions, with ON and OFF clearly marked.

REMOVE BATTERY DOOR TO ACCESS LEFT BUTTON CODING SWITCH

TO ACCESS THE RIGHT BUTTON CODING SWITCH, REMOVE THE CASE SCREW AND BACK OF CASE

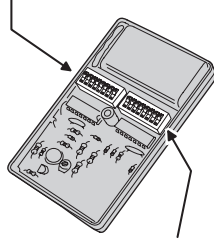
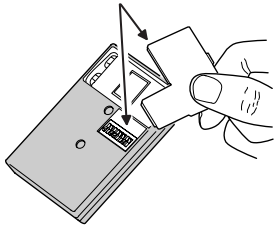

LEFT BUTTON CODING SWITCH

**STEP 2A Coding for single-channel receivers.** Pick two valid OFF/ON codes and set them on switches 1-8 on each coding switch in the transmitter. Set each receiver's coding switch 1-8 to match the code set for the proper button in the transmitter.

#### CODING SWITCHES IN D-22C TRANSMITTER

#### CODING SWITCHES IN TWO RECEIVERS

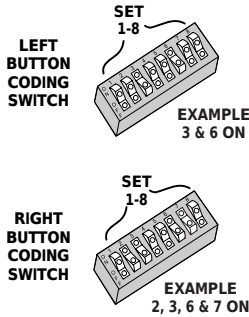

LEFT BUTTON CODING SWITCH

RIGHT BUTTON CODING SWITCH

RECEIVER #1 ACTIVATES FROM LEFT BUTTON

RECEIVER #2 ACTIVATES FROM RIGHT BUTTON

**STEP 2B Coding for two-channel receivers.** Pick one valid OFF/ON code and set it on switches 3-8 in the receiver. Match the same code on switches 3-8 on both switches in the transmitter. Set both the transmitter switches 2 to OFF. Set one transmitter switch 1 to OFF and the other switch 1 to ON. 2-Channel receiver switches 1 & 2 are unused and can be set in any position.

#### CODING SWITCHES IN D-22C TRANSMITTER

#### CODING SWITCHES IN TWO-CHANNEL RECEIVER

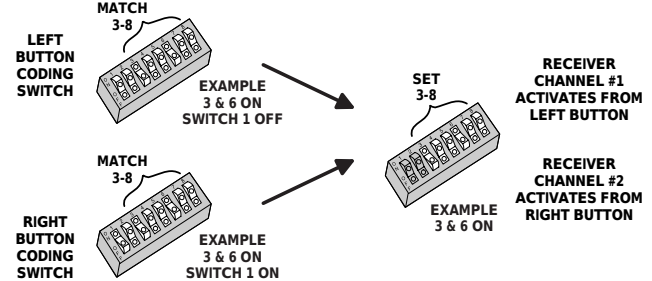

LEFT BUTTON CODING SWITCH

RIGHT BUTTON CODING SWITCH

RECEIVER CHANNEL #1 ACTIVATES FROM LEFT BUTTON

RECEIVER CHANNEL #2 ACTIVATES FROM RIGHT BUTTON

**STEP 3 Test the equipment.** Connect the receiver to its power source. With relay output receivers, listen for the relay click when the transmitter is activated. A multi-meter can be used to detect activation of relay and solid state output receivers. Operate the transmitter from various locations to determine the radio range.

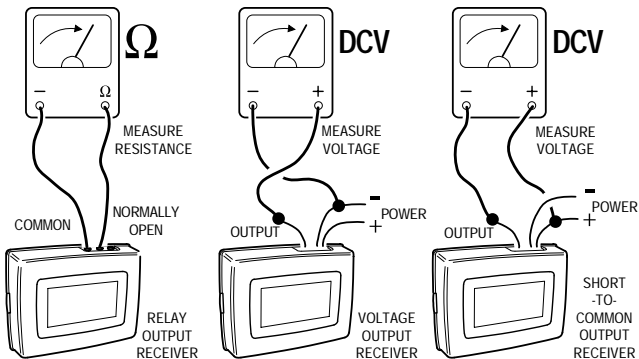

### BATTERY REPLACEMENT

The battery should last 12 to 18 months with normal use. When the red LED lights dimly, or not at all when transmitting, the battery needs to be replaced. Remove the battery access door to change the battery. Any type of 9-volt battery can be used. Replace the battery door and foam battery pad when finished.

REPLACE BATTERY WITH FRESH 9-VOLT BATTERY

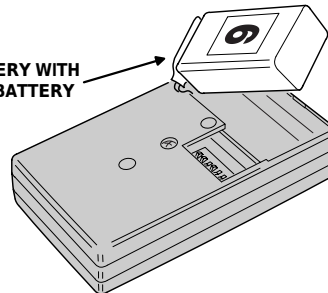

### LINEAR LIMITED WARRANTY

This Linear product is warranted against defects in material and workmanship for twelve (12) months. The Warranty Expiration Date is labeled on the product. This warranty extends only to wholesale customers who buy direct from Linear or through Linear's normal distribution channels. Linear does not warrant this product to consumers. Consumers should inquire from their selling dealer as to the nature of the dealer's warranty, if any. There are no obligations or liabilities on the part of Linear corporation for consequential damages arising out of or in connection with use or performance of this product or other indirect damages with respect to loss of property, revenue, or profit, or cost of removal, installation, or reinstallation. All implied warranties, including implied warranties for merchantability and implied warranties for fitness, are valid only until Warranty Expiration Date as labeled on the product. This Linear Corporation Warranty is in lieu of all other warranties express or implied.

All products returned for warranty service require a Return Product Authorization Number (RPA#). Contact Linear Technical Services at 1-800-421-1587 for an RPA# and other important details.

#### IMPORTANT !!!

Linear radio controls provide a reliable communications link and fill an important need in portable wireless signalling. However, there are some limitations which must be observed.

- \* For U.S. installations only: The radios are required to comply with FCC Rules and Regulations as Part 15 devices. As such, they have limited transmitter power and therefore limited range.
- \* A receiver cannot respond to more than one transmitted signal at a time and may be blocked by radio signals that occur on or near their operating frequencies, regardless of code settings.
- \* Changes or modifications to the device may void FCC compliance.
- \* Infrequently used radio links should be tested regularly to protect against undetected interference or fault.
- \* A general knowledge of radio and its vagaries should be gained prior to acting as a wholesale distributor or dealer, and these facts should be communicated to the ultimate users.